

Kryteria oceny PROKIT



Kontakt

PERI Polska Sp. z o.o.
Ul. Stołeczna 62
05-860 Płochocin
Telefon 22 7217400
info@peri.com.pl
www.peri.com.pl

Spis treści	Str.	Zmiany	Data Kto	Str.
Zabezpieczenie boczne z siatką PMB	2	Utworzenie nowej instrukcji	10/2016 I fw	
Słupek poręczy PP Nadstawka słupka poręczy PPE	4			
Uchwyt stropowy Uchwyt czołowy	5			
Zacisk PUC	6			
Zacisk PSC	7			
Znaczenie symboli	8			

Zabezpieczenie boczne z siatką PMB

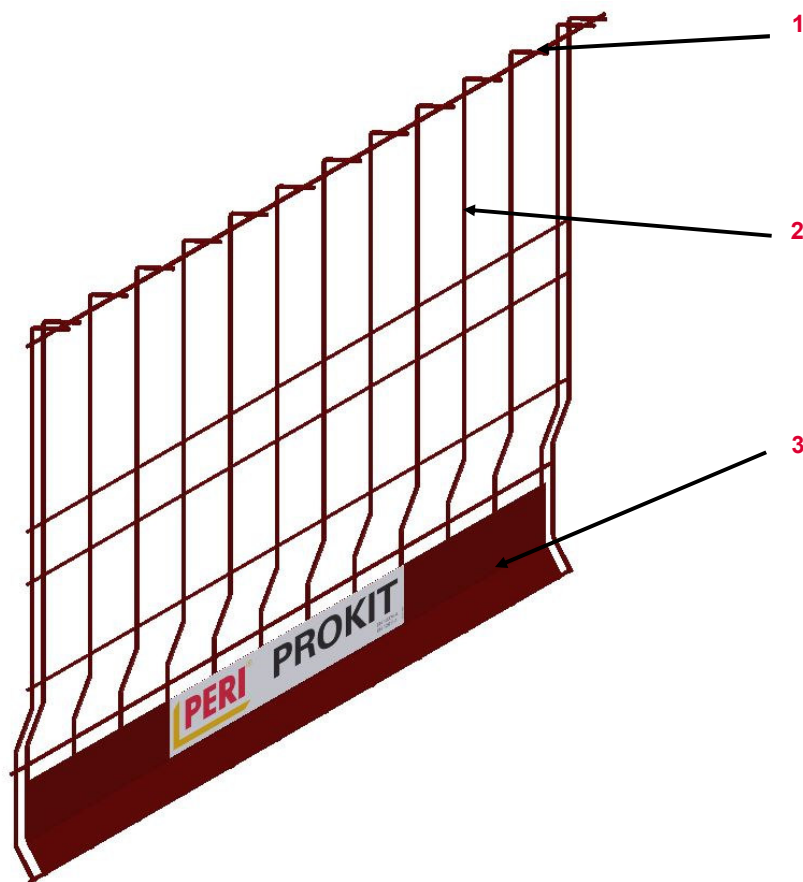

Poz.	Opis	Nr artykułu
------	------	-------------

1	Pręt poziomy	
---	--------------	--

2	Pręt pionowy	
---	--------------	--

3	Krawężnik	
---	-----------	--

Element	Nr artykułu
---------	-------------

















Zabezpieczenie boczne z siatką PMB 240	126371
--	--------

Zabezpieczenie boczne z siatką PMB 120	126376
--	--------

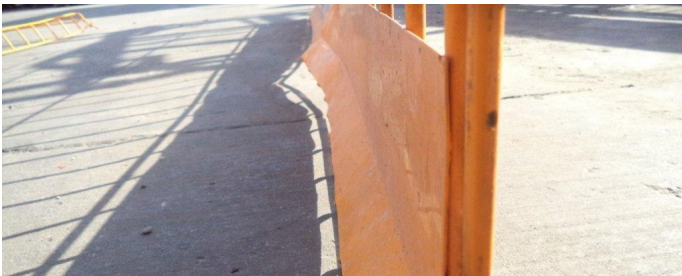
Zabezpieczenie boczne z siatką PMB 90	126381
---------------------------------------	--------











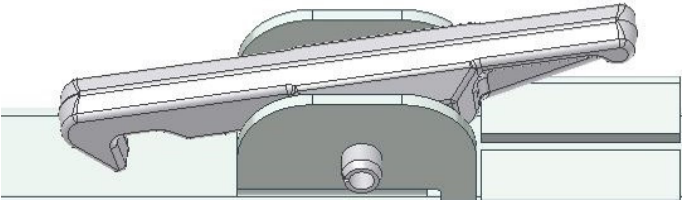





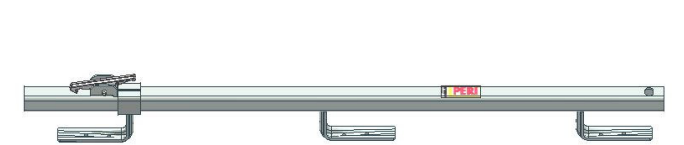





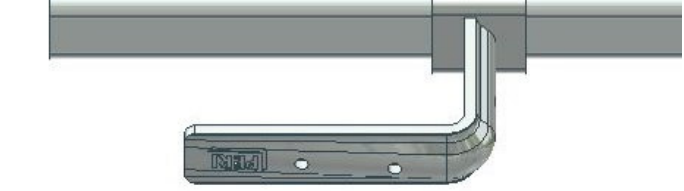

Zabezpieczenie boczne z siatką PMB 130	117327
--	--------

Zabezpieczenie boczne z siatką PMB 260	117236
--	--------

Zabezpieczenie boczne z siatką PMB	Opis	Instrukcja	Rozliczenie	Kat.
	Oderwanie pręta			
	Siatka			
	<ul style="list-style-type: none"> ■ wygięcie > 15 mm ■ załamanie 	 	 	 
	Wygięcie krawężnika			
	<ul style="list-style-type: none"> ■ wyprostowanie jest możliwe ■ wyprostowanie nie jest możliwe 	 	 	 

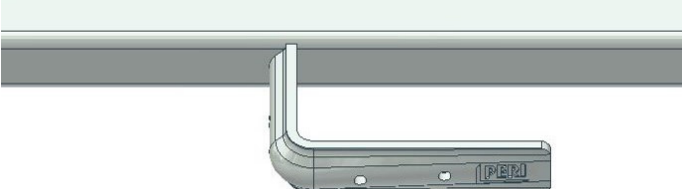
Kryteria oceny PROKIT



Słupek (117325) Nadstawka słupka (118296)	Opis	Instrukcja	Rozliczenie	Kat.
	Zapadka	<ul style="list-style-type: none"> ■ brak  710418 (zapadka hakowa) 724567 (kołek rozprężny) 		
	<ul style="list-style-type: none"> ■ uszkodzenie 	<ul style="list-style-type: none">  710418 (zapadka hakowa) 724567 (kołek rozprężny) 		
	Wgniecenie profilu	<ul style="list-style-type: none"> ■ bez uszkodzenia krawędzi  		
	<ul style="list-style-type: none"> ■ z uszkodzeniem krawędzi 	 		
	Uchwyt przesuwny	<ul style="list-style-type: none"> ■ brak  115673 (uchwyt poręczny) 		
	<ul style="list-style-type: none"> ■ uszkodzenie 	<ul style="list-style-type: none">  115673 (uchwyt poręczny) 		
	Uchwyt stały wygięty brak			

Uchwyt stropowy Uchwyt czołowy (117323; 117324)	Opis	Instrukcja	Rozliczenie	Kat.
---	------	------------	-------------	------

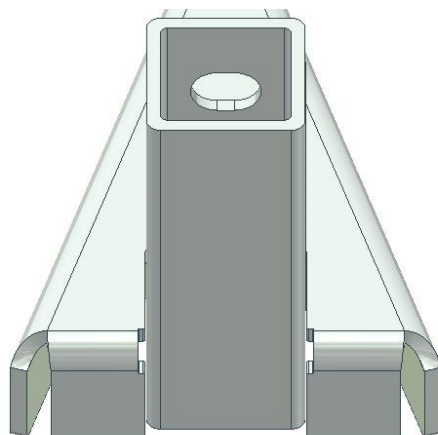

Wygięcie łącznika

- osadzenie słupka jest możliwe
- osadzenie słupka nie jest możliwe

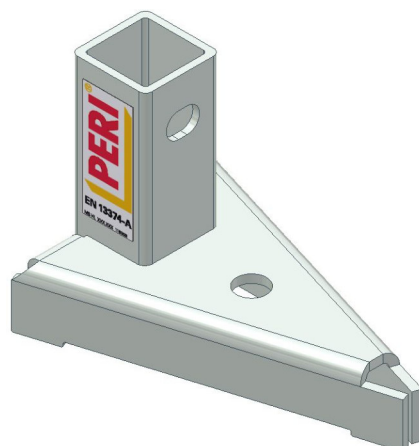

Wygięcie podstawy

- wyprostowanie jest możliwe
- wyprostowanie nie jest możliwe



Zacisk PUC (118660)	Opis	Instrukcja	Rozliczenie	Kat.
---------------------	------	------------	-------------	------



Wygięcie łącznika

- osadzenie słupka jest możliwe
- osadzenie słupka nie jest możliwe

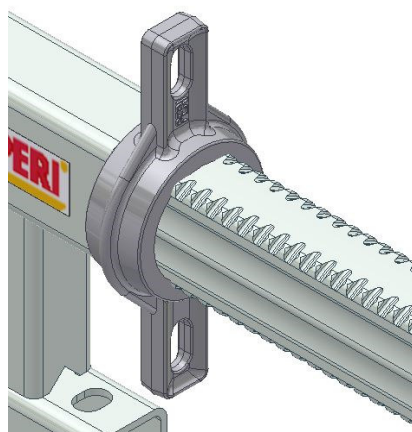

Nakrętka

- brak
- uszkodzenie



065048 (nakrętka do zacisku PUC)

065048 (nakrętka do zacisku PUC)



















Zacisk PSC (126330)	Opis	Instrukcja	Rozliczenie	Kat.
	Wygięcie łącznika			
	<ul style="list-style-type: none"> ■ osadzenie słupka jest możliwe ■ osadzenie słupka nie jest możliwe 	<ul style="list-style-type: none"> 	<ul style="list-style-type: none"> 	<ul style="list-style-type: none">
	Kolce			
	<ul style="list-style-type: none"> ■ brak ■ uszkodzenie 	<ul style="list-style-type: none"> 112662 (kolec zacisku PSC) 112662 (kolec zacisku PSC) 	<ul style="list-style-type: none"> 	<ul style="list-style-type: none">
	Śruba napinająca			
	<ul style="list-style-type: none"> ■ brak ■ uszkodzenie 	<ul style="list-style-type: none"> 126337 (śruba napinająca) 126337 (śruba napinająca) 	<ul style="list-style-type: none"> 	<ul style="list-style-type: none">

Kryteria oceny

Znaczenie symboli



Symbol	Znaczenie	Symbol	Znaczenie	Symbol	Znaczenie
	Materiał uszkodzony nie podlegający naprawie		Usługa płatna		Wada optyczna
	Element sprawny—pozostaje w CL		Bez obciążenia		Wada funkcjonalna
	Materiał uszkodzony nie podlegający naprawie - zakaz użytkowania ze wzgl. bezpieczeństwa		Skrócenie elementu		Wada funkcjonalna - zakaz użytkowania ze wzgl. bezpieczeństwa
	Naprawa wg instrukcji		Oznaczenie farbą		Wada statyczna - zakaz użytkowania ze wzgl. bezpieczeństwa
	Wyprostować na zimno po czym sprawdzić spoiny i przylegające części		Wymiana uszkodzonych części		
	Naprawa wg oceny ekonomicznej		Uzupełnienie brakujących części		
	Czyszczenie elementu				